



- obrousit - sand - abschleifen - sable - zand - smergliare - szlifować - obrusit' - csiszolni - отшлифовать - zmparalanacak - obrusiti - lijar
- vystřihnout - cut out - ausschneiden - découper - uitknippen - ritagliare - wyciąć - vystrihnúť - kivágni - вырезать - keslecek - izrezati - recortar
- čekat - wait - warten - attendre - wachten - aspettare - czekać - čekat' - várni - ждать - beklemecek - pričekati - tiempo de espera
- lepit disperzním lepidlem - dispersion glue - Dispersionsklebstoff - colle - oplosbare lijm - dispersione adesivo - klej - disperzno lepidlo - ragasztani - клеить дисперсионным клеем - yapıştırılacak - disperzivno leplivo - expandir pegamento

- oříznout - cut - schneiden - couper - snijden - tagliare - ciac' - orezat' - levágni - обрезат' - keslecek - odrezati - cortar
- malovat - paint - malen - peindre - verf - disegnaré - malować - malovať - festék
- kreslit - draw - zeichnen - dessiner - tekenen - dipingere - remis - kreslit' - húz

DŘEVĚNÁ SLEPOVACÍ STAVEBNICE
READY TO GLUE UP WOODEN KIT
HOLZBAUKASTEN ZUM ZUSAMMENKLEBEN

38 pcs 23 x 6 x 7 cm

Houpačka-Seesaw-Wippe

POPIS ITEM	ROZMĚR SIZE [mm]	NÁZEV NAME	ks pcs
	9x9x111	A	2
	9x9x37	T	4
	9x9x25	C	4
	9x9x16	D	2
	9x9x213	X	2
	9x9x50	V	4
	5x9x32	V1	4
	5x9x25	M	6
	4x4x45	U	2
	10x15	L	4
	ø 4x60	S	1
	170x65	P1	1
	31x28	P7	2

1.

2. $(C+2xT)+A+2xV = (A)$
(2x)
- na folii
- on the foil
- auf den Folien

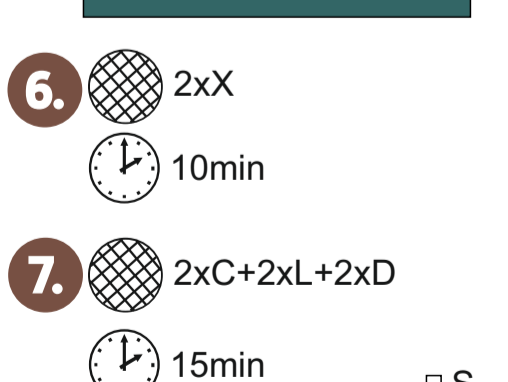
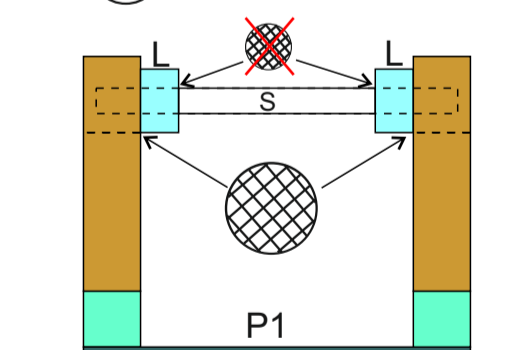
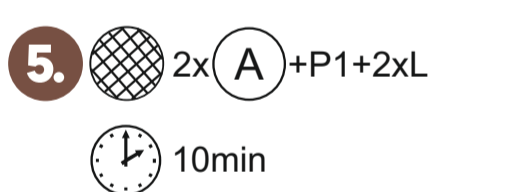
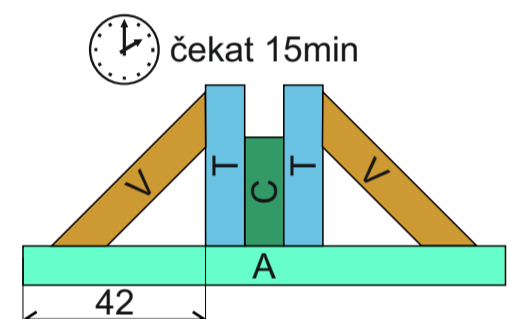

8. $P7+3xM+V1 = (B)$ (2x)

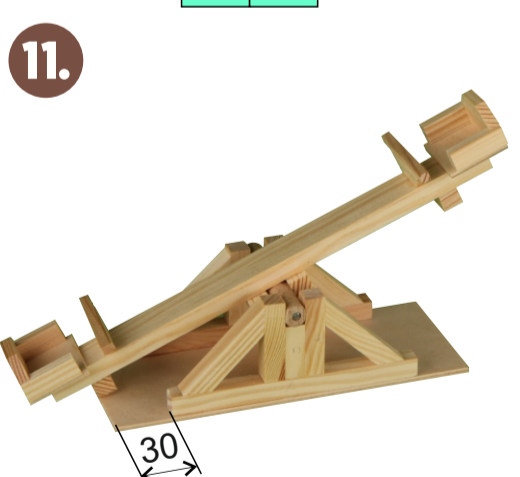
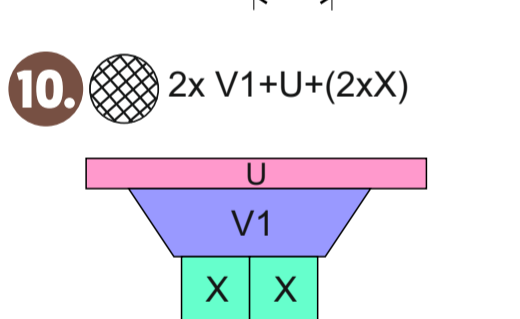
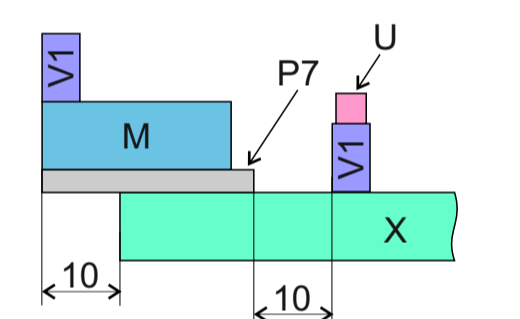
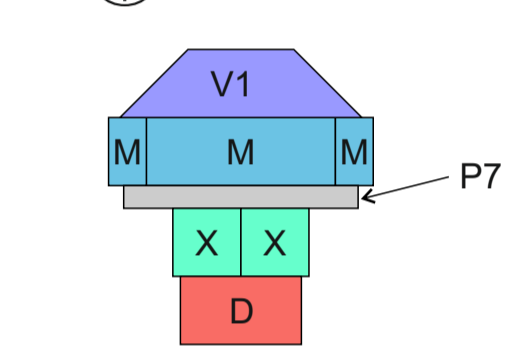
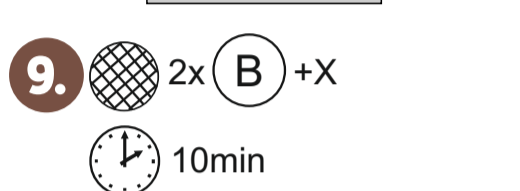
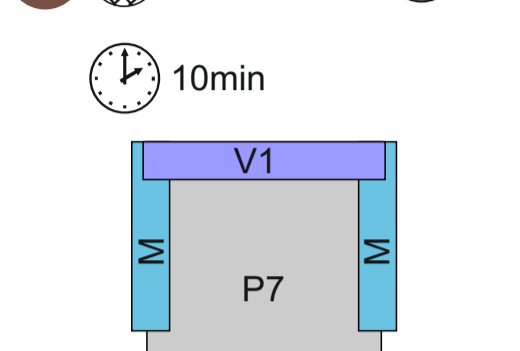

50 pcs 19 x 19 x 9 cm

Kolotoč-Carousel-Ringelspiel

POPIS ITEM	ROZMĚR SIZE [mm]	NÁZEV NAME	ks pcs
	9x9x111	A	4
	9x9x37	T	1
	9x9x41	J	6
	9x9x25	C	6
	9x9x50	V	8
	5x9x32	V1	4
	5x9x25	M	12
	ø 8x35	W	1
	8x16x32	Q	1
	100x100	P4	1
	31x28	P7	4
	71x71	P8	1
	71x71	P8v	1

1. P4

$Q+W+P4$

10min

2. $2xJ+2xC$

5min

3. $4xJ+4xC$

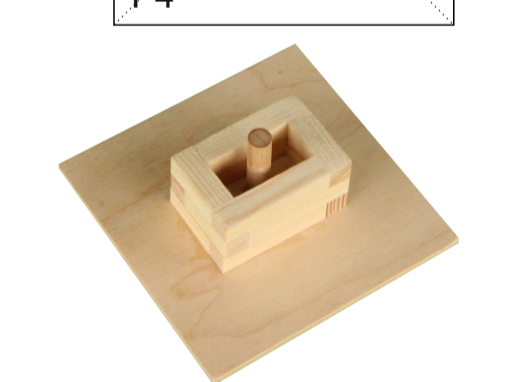

4. P8v

$P8v+4xA+4xV = (B)$

10min

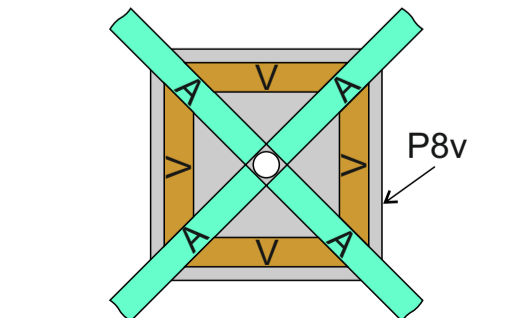

5. P8

$P8+(B)$

10min

6. $T+4xV$

10min

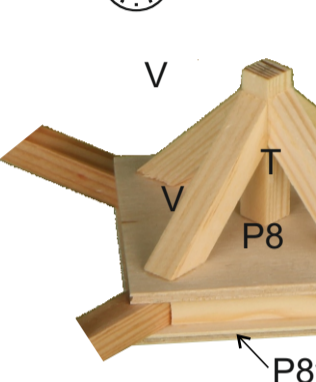

7. P7

$(P7+3xM+V1) = (C)$

10min

8. $4xA+(C)$

10min

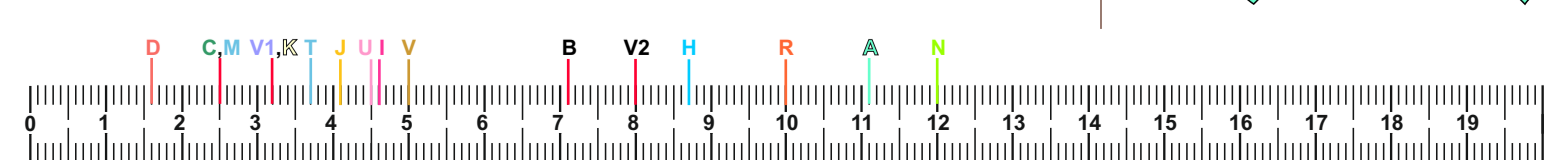



obrousit - sand - abschleifen - sable - zand
smiergliare - szlifować - obrusiti - csiszolni - отшлифовать
zmparalanacak - obrusiti - lijar

vystřihnout - cut out - ausschneiden - découper
uitknippen - ritagliare - wyciąć - vystrihnúť - kivágni - вырезать
kesilecek - izrezati - recortar

čekat - wait - warten - attendre - wachten - aspettare - czekać - čekat
várni - ждать - bekleńecek - pričekati - tiempo de espera

lepit disperzním lepidlem - dispersion glue - Dispersionsklebstoff
colle - oplosbare lijm - dispersione adesivo - Klej - disperzné lepidlo
ragasztani - клеить дисперсионным клеем - уяпіштірляцак -
disperzivno leplilo - expandir pegamento

oříznout - cut - schneiden - couper
snijden - tagliare - ciąć - orezat - levágni
obrezati - kesilecek - odrezati - cortar

malovat - paint - malen - peindre - verf
disegnare - malować - malovať - festék

kreslit - draw - zeichnen - dessiner - tekenen
dipingere - remis - kreslit - húz

DŘEVĚNÁ SLEPOVACÍ STAVEBNICE
READY TO GLUE UP WOODEN KIT
HOLZBAUKASTEN ZUM ZUSAMMENKLEBEN

57 pcs 27 × 10 × 12 cm

Skluzávka-Slide-Rutsche

POPIS ITEM	ROZMĚR SIZE [mm]	NÁZEV NAME	ks pcs
	9x9x111	A	4
	9x9x41	J	13
	9x9x25	C	12
	9x9x16	D	6
	9x9x87	H	6
	9x9x46	I	3
	5x9x80	V2	4
	170x65	P1	1
	40x40	P2	1
	85x40	P3	1
	100x100	P4	1
	81x42	P5	2
	59x59	P6	2
	∅ 3x70	Z	1

1. 6xJ+2xA (2x)
- na folii
- on the foil
- auf den Folien

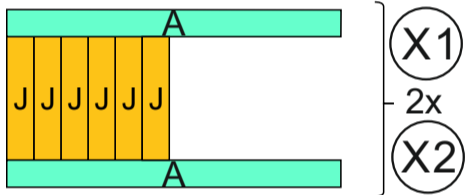

2. 4xC+ X1 10min

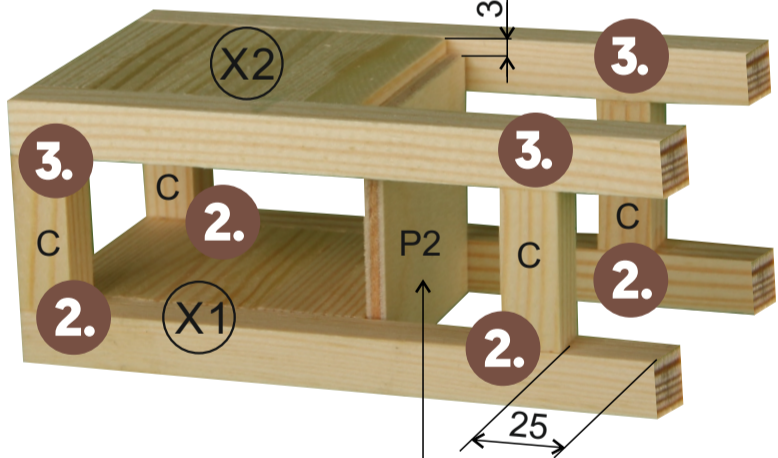

3. X2 10min

4. P2

5. V2+6xC 5min
 V2 5min

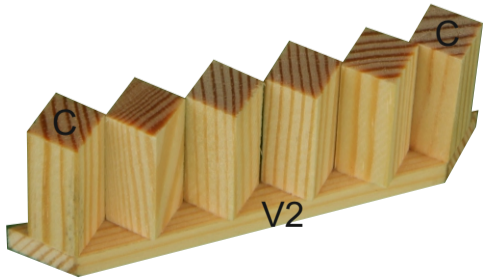

6. P3 2x 30°

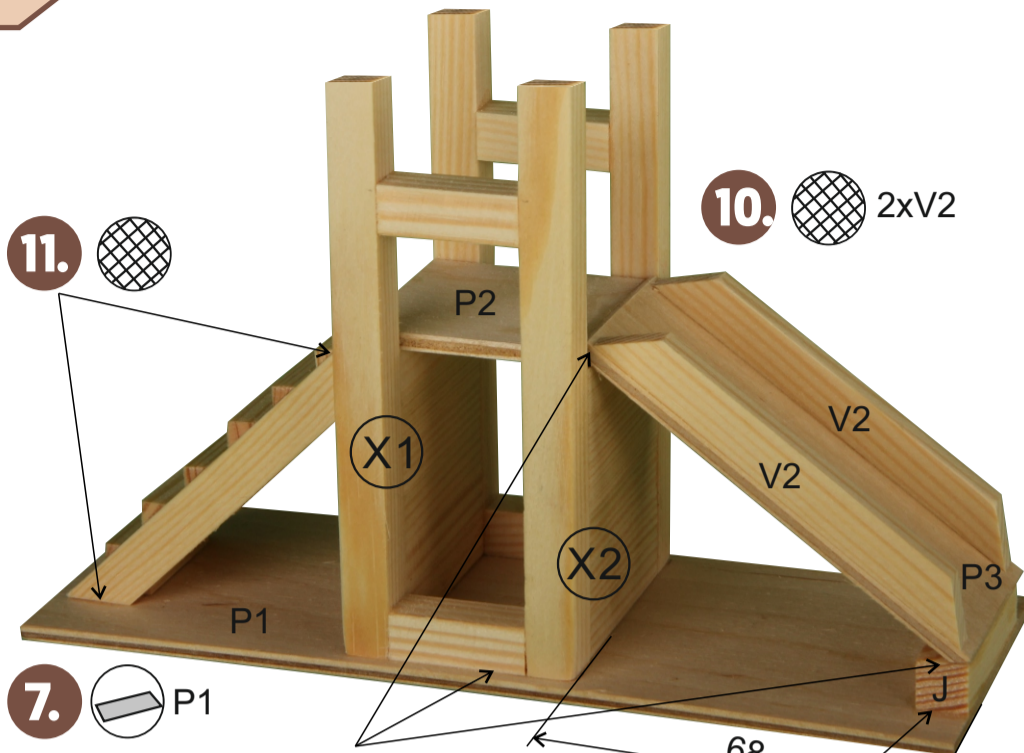
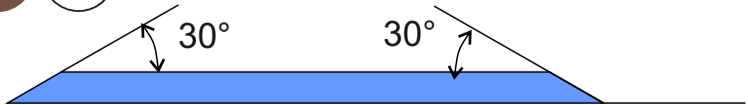

7. P1

9. P3+ X_{1,2}

8. J

12. 2xP6, 2xP5

13. P6+2xI+2xD

14. 2xP5 5min

15. P6+2xD+I

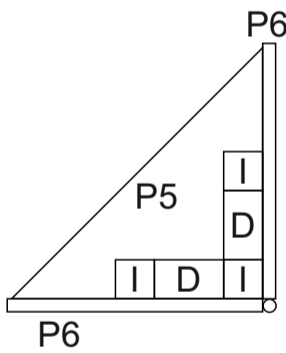
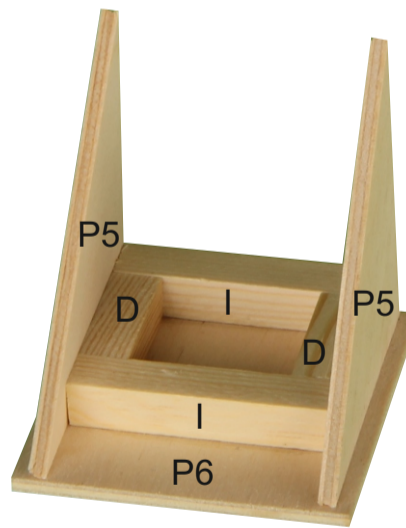

16. Z - 59mm

Z

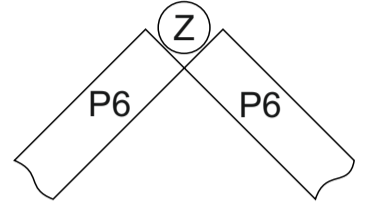

17. P4

6xH, 2xC, 2xD

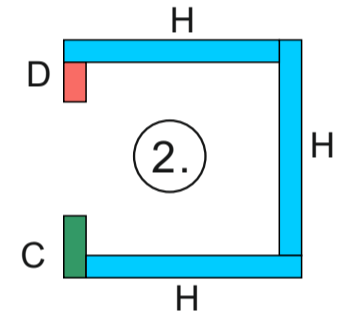
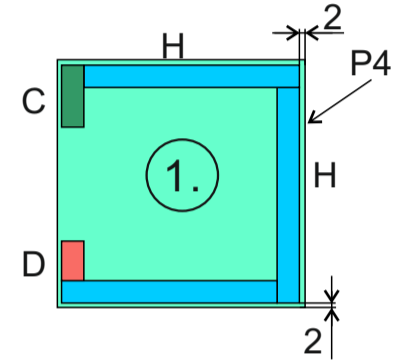



obrousit - sand - abschleifen - sable - zand
smiergliare - szlifować - obrusiti - csiszolni - отшлифовать
zmparalanacak - obrusiti - lijar

vystřihnout - cut out - ausschneiden - découper
uitknippen - ritagliare - wyciąć - vystrihnúť - kivágni - вырезать
kesilecek - izrezati - recortar

čekat - wait - warten - attendre - wachten - aspettare - czekać - čekat
várni - ждать - bekleńecek - pričekati - tiempo de espera

lepit disperzním lepidlem - dispersion glue - Dispersionsklebstoff
colle - oplosbare lijm - dispersione adesivo - Klej - disperzno lepidlo
ragasztani - клеить дисперсионным клеем - уapiштрilacak -
disperzivno leplilo - expandir pegamento

oříznout - cut - schneiden - couper
snijden - tagliare - ciąć - orezat - levágni
obrezati - kesilecek - odrezati - cortar

malovat - paint - malen - peindre - verf
disegnare - malować - maľovať - festék

kreslit - draw - zeichnen - dessiner - tekenen
dipingere - remis - kreslit - húz

DŘEVĚNÁ SLEPOVACÍ STAVEBNICE
READY TO GLUE UP WOODEN KIT
HOLZBAUKASTEN ZUM ZUSAMMENKLEBEN

31 pcs 8 x 12 x 14 cm

Houpačka-Swing-Schaukel

POPIS ITEM	ROZMĚR SIZE [mm]	NÁZEV NAME	ks pcs
	9x9x120	N	6
	9x9x46	I	4
	9x9x71	B	2
	9x9x32	K	4
	9x9x50	V	4
	5x9x100	R	2
	5x9x25	M	2
	10x15	L	3
	ø 4x60	S	1
	ø 6x30	Y	1
	122x73	P9	1
	31x28	P7	1

1. 3xN+2xI+2xV = (A)
(2x)
- na folii
- on the foil
- auf den Folien

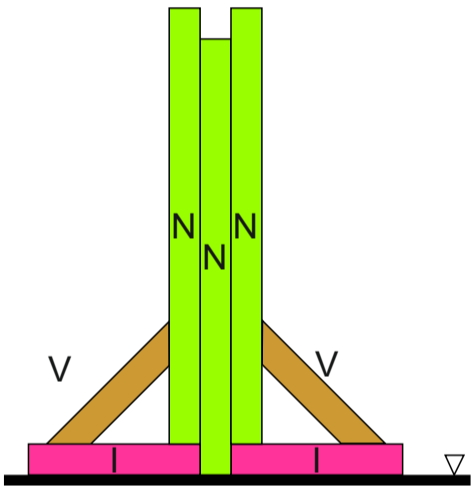

2. P9

3. P9 + 2x (A)

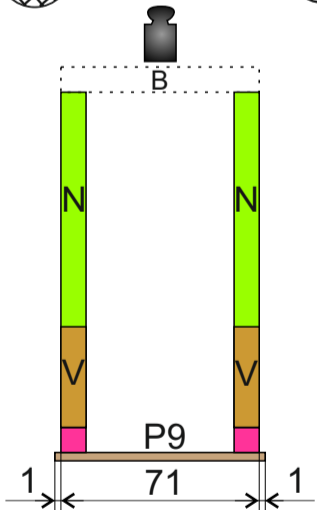

4. 2xL

5. 2xL + (A)

10min

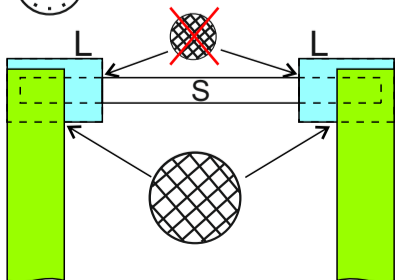

6. L

7. L+K

10min

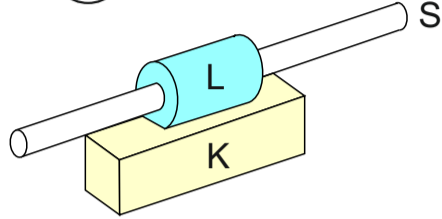

8. 2xR

K+2xR = (B)

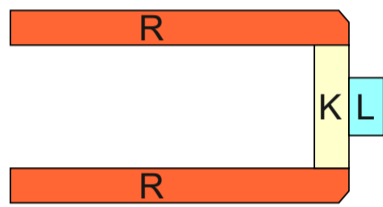

9. 3xK = (C)

10min

P7+2xM

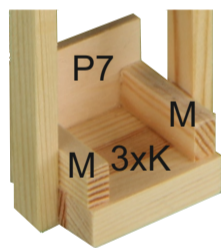

10. (B) + (C)

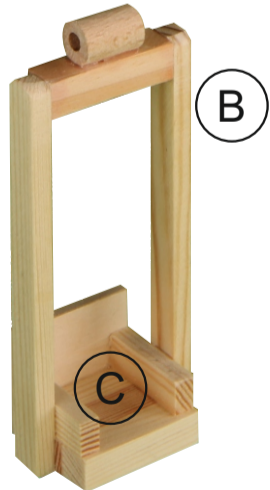

11. 2xY - 12 mm

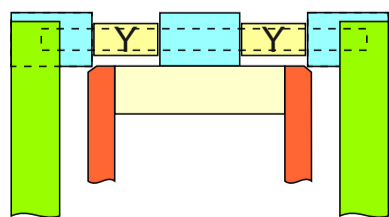

12. 2xB

